

TECHNICAL INFORMATIONS

PROJETOR ASTRO IP66

200W 4000K

Série profissional de projetores IP66, corpo em alumínio fundido de alta intensidade, vidro temperado de alta qualidade que resiste ao impacto e ao atrito.

Professional floodlight series IP66, body of high intensity die-cast aluminum, high quality tempered glass that resist the impact and friction.

Serie profesional de proyectores IP66, cuerpo de aluminio fundido de alta intensidad, vidrio templado de alta calidad que resiste el impacto y la fricción.



ILAR-01924

REFERENCE		DIMENSION & WEIGHT		PHOTOMETRICAL DATA	
Reference	ILAR-01924	Size Piece	389x354x63mm	Total Luminous Flux	30000lm
Led Type	Philips LED	Weight Piece	-	Luminous Efficacy	150lm/W
Body Material	Aluminum Die-Cast ADC12	Item Volume	-	Beam Angle	90°
Body Colour	Black	Items per Pack	1	Colour Temperature	4000K
Nominal Lifetime (Tm21: L80B10)	>50000H	Items per Box	1	Colour Rendering Index	>70
Driver Brand	Sonser Driver			SDCM	<6
Dimmable	NO				

ELECTRICAL AND OPERATING DATA		ENERGY LABEL & STANDARS		CERTIFICATIONS	
Nominal Wattage	200W	Type of Protection	IP66	CE Directive	YES
Nominal Voltage	100-277V	Protection Class	Class I	ROHS	YES
Operating Frequency	50/60Hz	Protection Class IK (shock resistance)	IK08	Warranty	3 YEARS
Power Factor	>0.95	Surge Protection	4Kv		
Operating Temperature	-40°C to + 50°C	Protection	OTP, OCP, OVP, SCP		
Power Supply	Built in	Thermal Conductivity	96 W/m-K		

SIZE

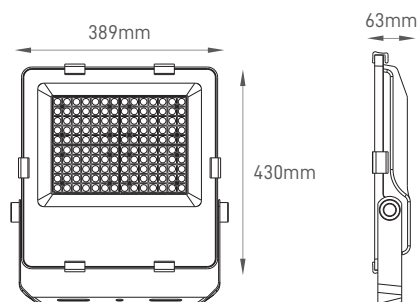

BEAM ANGLE

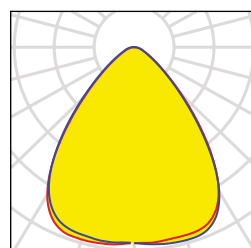

Designed by Aronlight in Portugal. Made in PRC

